

▶ Custom Pro Matrix

User Manual

Thank you for purchasing this product.

For optimum performance and safety, please read these instructions carefully before connecting, operating or adjusting this product. Please save / keep this manual for future reference.



Surge Protection Device Recommended

This product contains sensitive electrical components that may be damaged by electrical spikes, surges, electric shock, lightning strikes, etc. Use of surge protection systems is highly recommended in order to protect and extend the life of your equipment.

Safety & Performance Notice

The transmission distances of HDMI over UTP cables are measured using TE CONNECTIVITY 1427071-6

EIA/TIA-568-B termination (T568B) of cables is recommended for optimal performance.

To minimise interference of the unshielded twisted pairs in the CAT5e/6/6a cable do not run the

HDBaseT™ / CAT5e/6/6a cabling with or in close parallel proximity to mains power cables.

Do not substitute or use any other power supply other than the enclosed unit, or a Blustream approved replacement.

Do not disassemble either the Transmitter or Receiver units for any reason. Doing so will void the manufacturer’s warranty.

Contents

- Introduction & Key Features _____ 03
- Modular Matrix Options Overview _____ 03
- Panel Descriptions - 8x8 Chassis _____ 04
- Panel Descriptions - 16x16 Chassis _____ 05
- Modular Options - Main Communication Board _____ 06
- Modular Options - Input Boards _____ 07 - 08
- Modular Options - Output Boards _____ 09 - 11
- Automatic Smart Scaling Functionality in CSC _____ 11
- Modular Options - Feature Boards _____ 12
- Installing Modular Matrix Boards _____ 13
- HDBaseT™ Transmitter & Receiver Options _____ 14
- Matrix Front Panel Control _____ 15
- Advanced EDID Management _____ 16
- Terminating CAT Cables for use with HDBaseT™ _____ 16
- Understanding the HDBaseT™ Status LED’s _____ 17
- Audio Functionality _____ 18
- Infrared Distribution _____ 19
- Infrared Control _____ 20
- Example Schematic - 8x8 Chassis _____ 21
- Example Schematic - 16x16 Chassis _____ 22
- Specifications, Package Contents & Maintenance _____ 23
- Infrared Commands - 8x8 Matrix _____ 24 - 25
- Infrared Commands - 16x16 Matrix _____ 26 - 27
- RS-232 and Telnet Commands _____ 38 - 30
- Certifications _____ 31
- Notes _____ 32

Introduction

The Blustream Custom Pro matrix series achieves new levels of performance and flexibility. AV installers can now easily specify their desired I/O structure and choose the additional control features required for a specific project. The Custom Pro matrix chassis' have been specifically designed to operate in challenging AV environments. The robust housing and interlocking board configuration make both installation and maintenance a seamless experience. Advanced features include audio breakout, IR routing, HDBaseT™ inputs, simultaneous HDBaseT™ / HDMI outputs, RS-232 pass through and a web browser interface module for control and configuration of the matrix (subject to I/O card specification).

Key Features

- 2-way and 4-way interchangeable input & output boards
- Optional control boards: IR routing (8x8 chassis only), zone audio breakout, RS-232 pass-through to supported HDBaseT™ receivers
- Supports 4K UHD video up to 70m (4K @60Hz 4:4:4) and up to 100m 1080p using HDBaseT™ distribution for all 2nd generation HDMI2.0 and HDBaseT™ CSC input / output boards (subject to output board specifications)
- Web browser interface for control and configuration of the matrix
- Control via front panel, IR, RS-232, TCP/IP, and iOS / Android apps (search: 'Blustream Matrix')
- Supports PoC (Power over Cable) to power compatible HDBaseT™ receivers
- 3rd party drivers available for major control brands - refer to Blustream website for more details
- Advanced EDID management
- HDCP 2.2 compliant

Modular Matrix Options Overview

The Custom Pro series allows AV integrators to easily specify their desired input / output structure, choosing the additional control features as required for a specific project. The available modular board options are shown below:

Chassis	
CUSTOMPRO-HUB	Custom Pro Matrix Hub (8x8)
CUSTOMPRO-HUB16	Custom Pro Matrix Hub (16x16)

Feature & Control Boards	
PRO-8IR*	8-Way IR Control Board (5V IR only)
PRO-8IR-V2*	8-Way IR Control Board w. 5V & 12V IR
PRO-8RS232	8-Way RS-232 Breakout Board
PRO-8AB	8-Way Audio Breakout Board
PRO-8AB-V2	8-Way Audio Breakout Board w. LL Volume

18Gbps Video Input Boards (4K 60Hz 4:4:4)	
PRO-IN2HAB	2-Way HDMI 2.0 Input Board w. Audio B/O
PRO-IN4HAB	4-Way HDMI 2.0 Input Board w. Audio B/O
PRO-IN4HDA	4-Way HDMI 2.0 Input Board w. Dante
PRO-IN2H2TCS	2-Way HDBaseT™ & HDMI 2.0 Input Board

18Gbps Video Output Boards (4K 60Hz 4:4:4)	
PRO-OUT2H-V2	2-Way HDMI 2.0 Output Board
PRO-OUT4H-V2	4-Way HDMI 2.0 Output Board
PRO-OUT2TCS	2-Way HDBaseT™ CSC Output Board (100m 1080p)
PRO-OUT4TCS	4-Way HDBaseT™ CSC Output Board (100m 1080p)
PRO-OUT4HTCS	4-Way HDBaseT™ CSC / HDMI Output Board (100m 1080p)
PRO-OUT2TL-V2	2-Way HDBaseT™ CSC Output Board (70m 1080p)
PRO-OUT4TL-V2	4-Way HDBaseT™ CSC Output Board (70m 1080p)
PRO-OUT4TLS-V2	4-Way HDBaseT™ CSC / HDMI Output Board (70m 1080p)

* IR control boards are included within the CUSTOMPRO-HUB16

Please note that the legacy (HDMI1.4, HDBaseT™ 4K 60Hz 4:2:0) Custom Pro input and output boards are not included within this user guide. Please contact your authorised Blustream distributor or reseller for further information.

Panel Descriptions - 8x8 Chassis

Front Panel

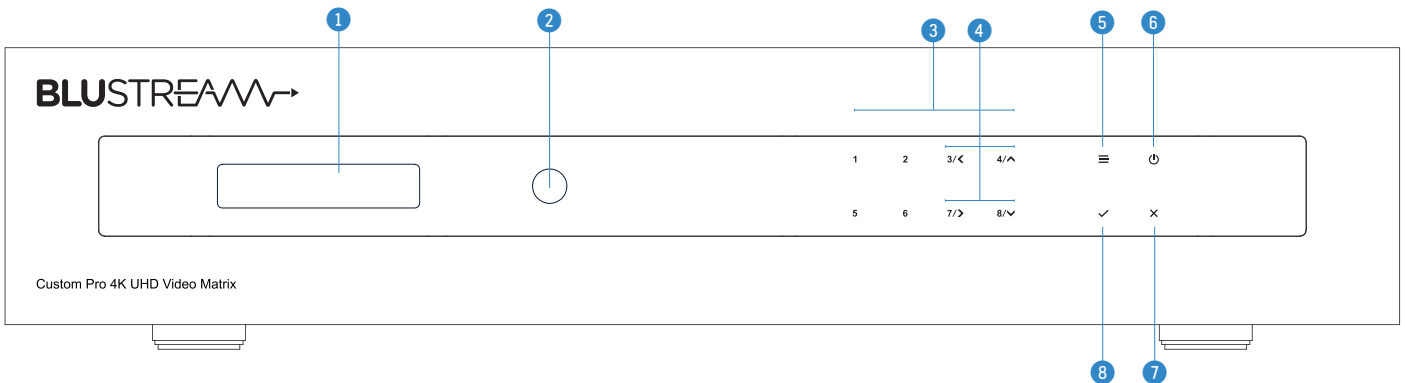

- 1 LCD display - shows the status of input / output selection, EDID etc.
- 2 IR receiver window
- 3 Input / output selection buttons - select output number first followed by the input to be viewed
- 4 Up / Down / Left / Right selection buttons - for use when navigating through matrix menu
- 5 Menu button - press to enter menu structure - see page 15 for more details
- 6 Power button - press and hold for 2 seconds to power off
- 7 Exit / Cancel button - return to last menu page / exit to main display page
- 8 Enter / Confirm button

Rear Panel

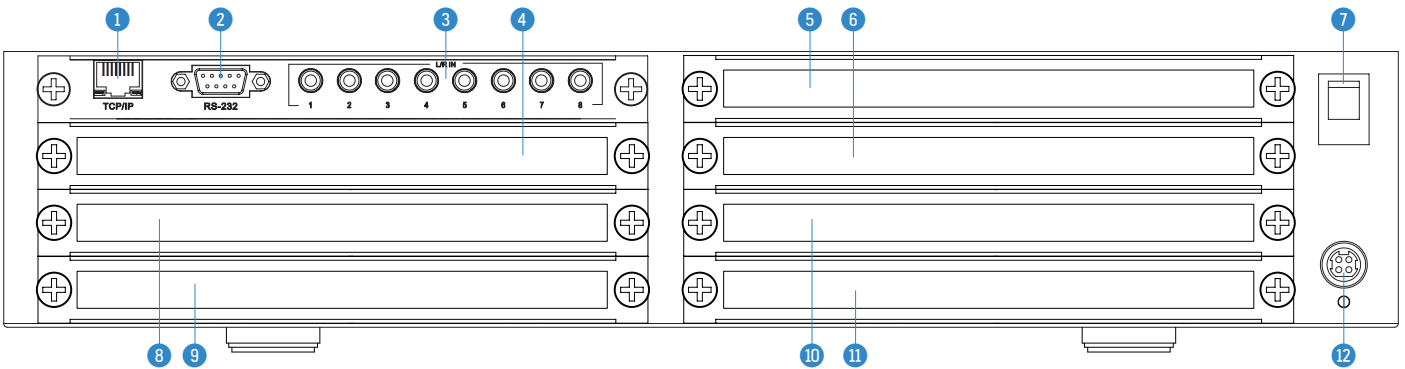

- 1 TCP/IP port - for control of the matrix from PC or third party control processor
- 2 RS-232 / serial connector - for control of the matrix (as above)
- 3 Analogue L/R line level input (3.5mm stereo jack) audio can be embedded onto video inputs
- 4 RS-232 control card slots - insert optional RS-232 control cards for serial control at HDBaseT™ receivers
- 5 Audio output card slot - insert optional audio card for zone / output audio breakout
- 6 IR control card slot - insert optional IR control card for 2-way & Global IR control
- 7 Mains power switch
- 8 Video input card 1 (inputs 1-4) - insert video input card to connect to source devices (mandatory)
- 9 Video input card 2 (inputs 5-8) - insert video input card to connect to source devices (optional)
- 10 Video output card 1 (outputs 1-4) - insert video output card (mandatory)
- 11 Video output card 2 (outputs 5-8) - insert video output card (optional)
- 12 Power port – use supplied 24V 8A DC adaptor to power matrix

Panel Descriptions - 16x16 Chassis

Front Panel - touch panel shown only for illustrative purposes

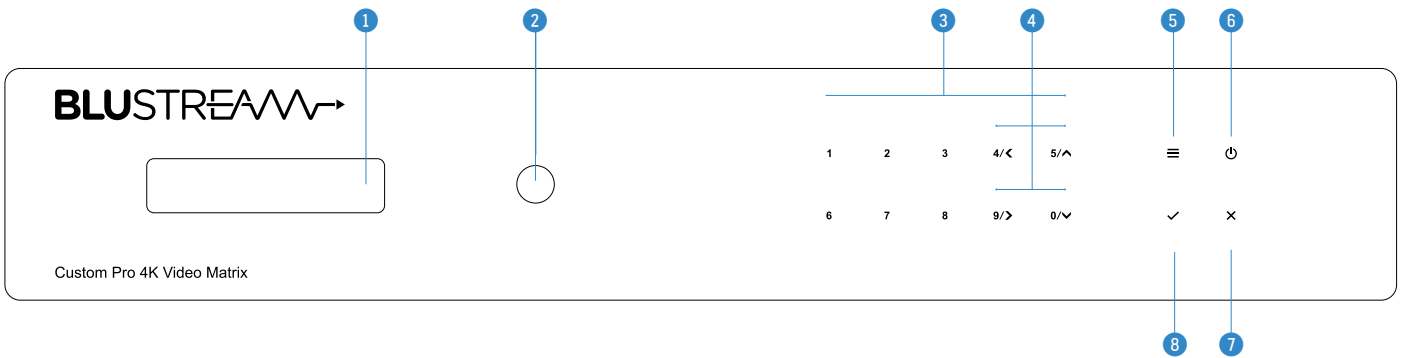

- 1 LCD display - shows the status of input / output selection, EDID etc.
- 2 IR receiver window
- 3 Input / output selection buttons - select output number first (up to 2 digits), followed by enter, then input number
- 4 Up / Down / Left / Right selection buttons
- 5 Menu button -press to enter menu structure - see page 15 for more details
- 6 Power button - press and hold for 2 seconds to power off
- 7 Exit / Cancel button- return to last menu page / exit to main display page
- 8 Enter / Confirm button

Rear Panel

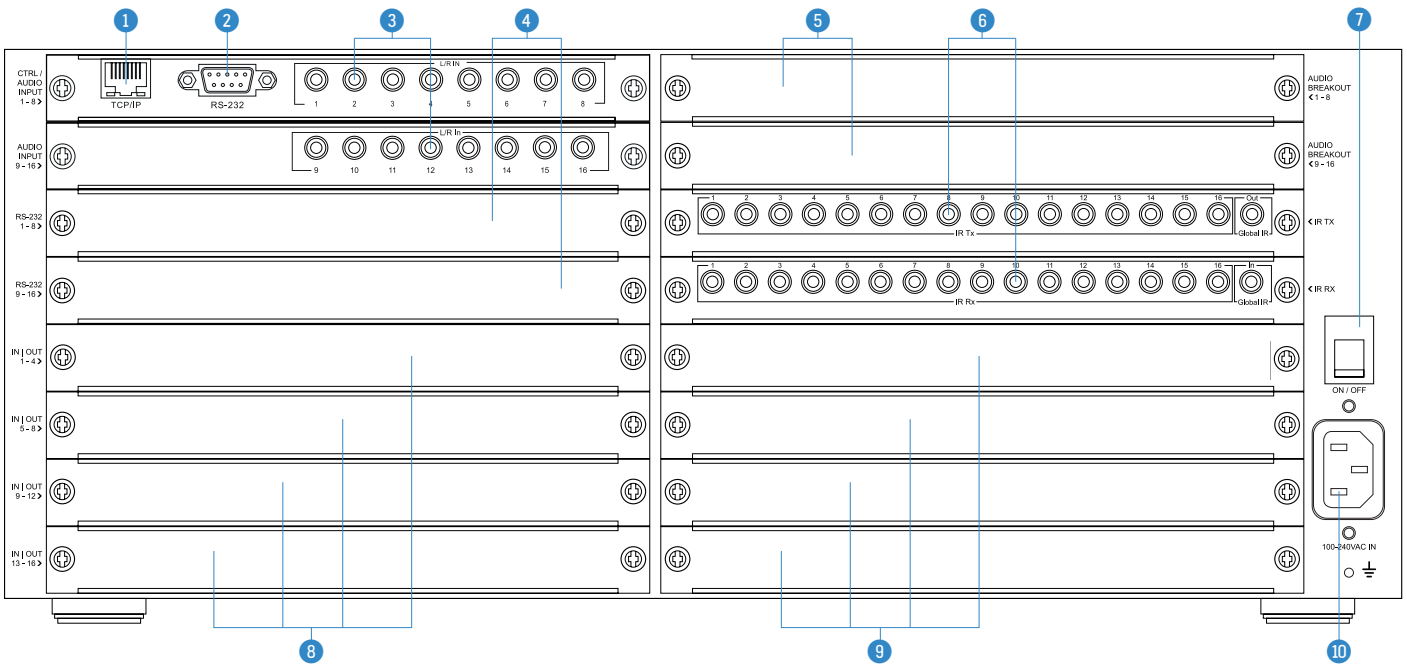

- 1 TCP/IP port - for control of the Matrix from PC or third party control processor
- 2 RS-232 / serial connector - for control of the matrix (as above)
- 3 Analogue L/R line level inputs (3.5mm stereo jack) Audio can be embedded onto video outputs
- 4 RS-232 control card slots - insert optional RS-232 control cards for serial control at HDBase™ receivers
- 5 Audio output card slots - insert optional audio cards for zone / output audio breakout
- 6 IR control card slots - IR control card for 2-way & Global IR control (supplied within 16x16 chassis)
- 7 Mains power switch
- 8 Video input card slots 1-4 (inputs 1-16) - insert video input cards to connect to source devices (input card slot 1 mandatory; 2-4 optional)
- 9 Video output card slots 1-4 (outputs 1-16) - insert video output cards (output card slot 1 mandatory; 2-4 optional)
- 10 Power port – use supplied IEC cable to power matrix

Custom Pro Matrix Modular Options

Each of the Custom Pro modular boards feature quick release card module fittings allowing simple installation into the Custom Pro matrix chassis.

The following pages list the Custom Pro modular board options available for both chassis.

Matrix Communication Board

Both Blustream Custom Pro matrix chassis' include a web browser interface module for control and configuration of the matrix, RS-232 for 3rd party control, as well as analogue audio embedding per zone. The Matrix Communication Board is supplied as standard with both Custom Pro chassis', the second communication board with 8 x L/R Audio inputs is supplied within the 16x16 chassis as standard.

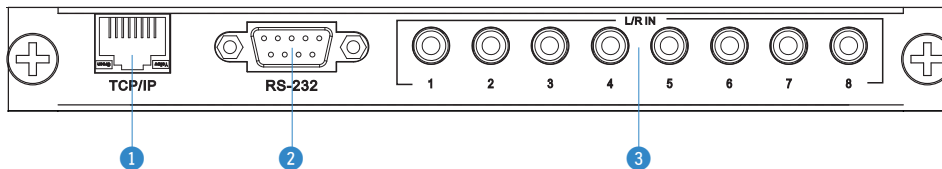

- 1 TCP/IP – for control of matrix (RJ45 connector)
- 2 RS-232 - 2-way (DB9) for 3rd party control of matrix
- 3 L/R 2ch analogue audio input - embeds and replaces the associated video input audio signal

TCP/IP

The Blustream matrix can be fully controlled via TCP/IP. For a full list of protocols please see 'RS-232 & Telnet Commands' located at the rear of this manual. A 'straight-through' RJ45 patch lead should be used.

RS-232

The Blustream matrix can be controlled via the 9-pin serial connection. For details of RS-232 pin assignment, communication, and a full list of protocols please see 'RS-232 & Telnet Commands' located at the rear of this manual.

Web GUI

Custom configuration of the matrix can be achieved using the matrix web-GUI interface. By default, the matrix is set to DHCP so will automatically obtain an IP address based on your routers configuration.

If you are unsure of the IP address of the Custom Pro matrix you can use the front panel menu to report the IP address of the unit. See page 15 for more details. If not connected to a local network, a direct connection is to be made to the matrix from a PC using a straight RJ45 CAT network patch cable. When the matrix is not assigned an IP address by a router, the default IP address will be **192.168.0.200**.

Default login details are:

Username: admin
Password: 1234

For further details and instructions on using the matrix web-GUI, please download the Blustream 'Web GUI & App Interface Guide' from the Blustream website.

Custom Pro Matrix Input Boards

PRO-IN4HAB - 4-Way HDMI 2.0 Input Board with Source Audio Breakout (4K 60Hz 4:4:4 - 18Gbps)

- 4 x HDMI 2.0, female
- L/R 3.5mm stereo jack audio breakouts - allow for 2ch source audio to be sent to separate audio distribution system. **Please Note:** audio breakout does not down-mix multichannel audio to 2ch.

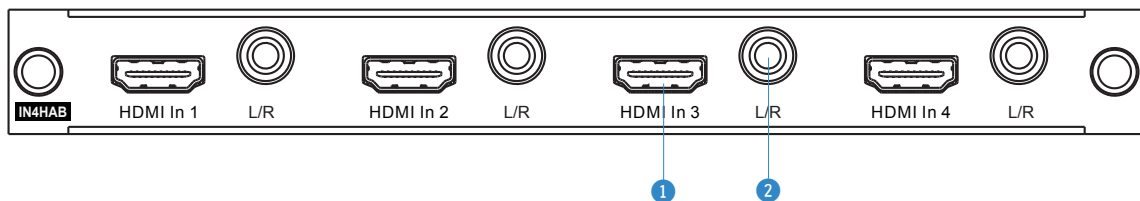

- ① HDMI Inputs
- ② L/R 3.5mm stereo audio breakout

PRO-IN2HAB - 2-Way HDMI 2.0 Input Board with Source Audio Breakout (4K 60Hz 4:4:4 - 18Gbps)

- 2 x HDMI 2.0, female
- L/R 3.5mm stereo jack audio breakouts - allow for 2ch source audio to be sent to separate audio distribution system. **Please Note:** audio breakout does not down-mix multichannel audio to 2ch.

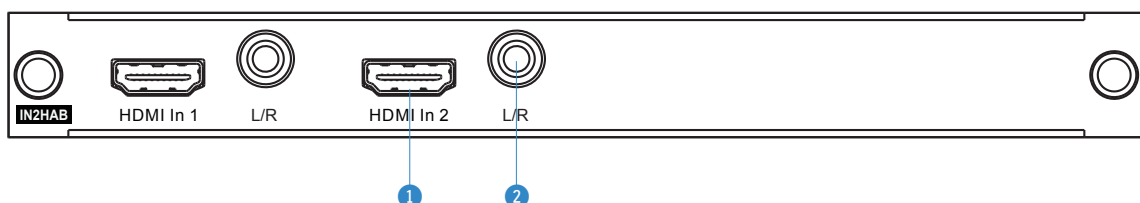

- ① HDMI Inputs
- ② L/R 3.5mm stereo audio breakout

Custom Pro Matrix Input Boards

PRO-IN4HDA - 4-Way HDMI 2.0 Input Board with Dante

- 4 x HDMI 2.0, female
- L/R 3.5mm stereo jack audio breakouts - allow for 2ch source audio to be sent to separate audio distribution system. **Please Note:** audio breakout does not down-mix multichannel audio to 2ch.
- Dante embedding / de-embedding connectivity. Send any of the 4 x stereo audio inputs (de-embedded from the incoming HDMI signal and send into a Dante ecosystem. Embed audio from within a Dante network onto the HDMI incoming video.

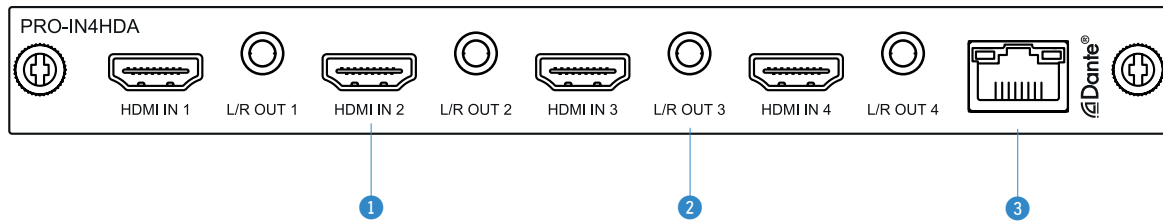

- ① HDMI Inputs
- ② Stereo audio breakout
- ③ Dante connection, RJ45, female

PRO-IN2H2TCS - 4-Way CSC HDBaseT™ & HDMI 2.0 Input Board (4K 60Hz 4:4:4 - 18Gbps)

- 2 x CSC HDBaseT™, RJ45
- 2 x HDMI 2.0, female
- Supports 70m at 4K 60Hz 4:4:4, or 100m at 1080p when used with the HEX100CS-TX (sold separately)
- HEX70CS-TX can be used where CAT cable distance is less than 40m at 4K 60Hz 4:4:4, or 70m at 1080p

Please Note: PoC (Power over Cable) is not supplied from the HDBaseT™ input ports. HEX70CS-TX or HEX100CS-TX units must be powered locally using a Blustream 12V 2A power supply (part code: PS122) which must be purchased separately.

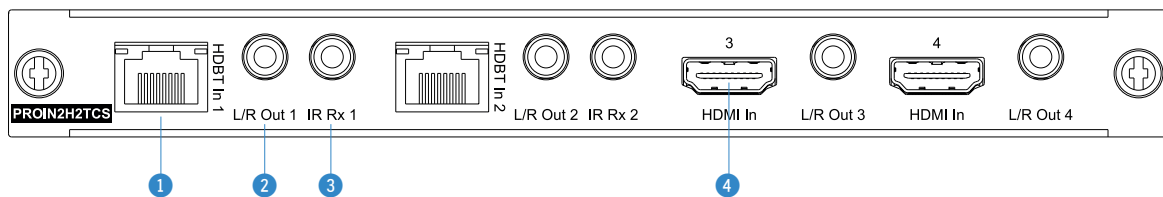

- ① HDBaseT™ Inputs (RJ45)
- ② L/R 3.5mm stereo audio breakout
- ③ IR RX 1 - 3.5mm Mono 5V IR output for routed control of remote source hardware
- ④ HDMI Inputs

Custom Pro Matrix Output Boards

PRO-OUT4H-V2 - 4-Way HDMI 2.0 Output Board (4K 60Hz 4:4:4 - 18Gbps)

- 4 x HDMI 2.0, female

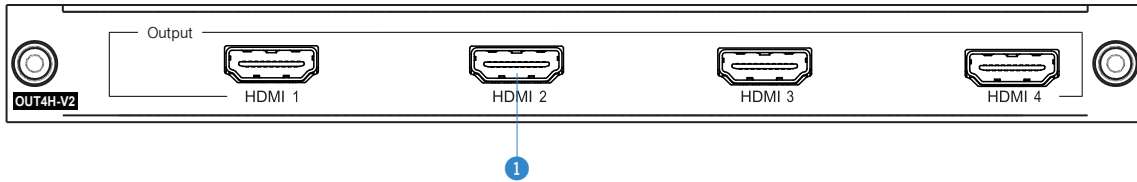

- 1 HDMI Outputs

PRO-OUT2H-V2 - 2-Way HDMI 2.0 Output Board (4K 60Hz 4:4:4 - 18Gbps)

- 2 x HDMI 2.0, female

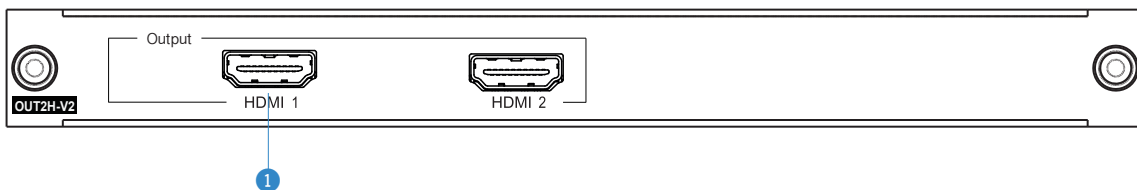

- 1 HDMI Outputs

PRO-OUT4HTCS - 4-Way HDBaseT™ CSC / HDMI 2.0 Output Board (4K 60Hz 4:4:4 - 18Gbps to 70m)

- 4 x HDBaseT™ CSC, RJ45
- 4 x simultaneous HDMI 2.0, female
- Supports 70m at 4K 60Hz 4:4:4, or 100m at 1080p when used with the HEX100CS-RX
- HEX70CS-RX can be used where CAT cable distance is less than 40m at 4K 60Hz 4:4:4, or 70m at 1080p
- Supports PoC (Power over Cable) to compatible Blustream HDBaseT™ receivers

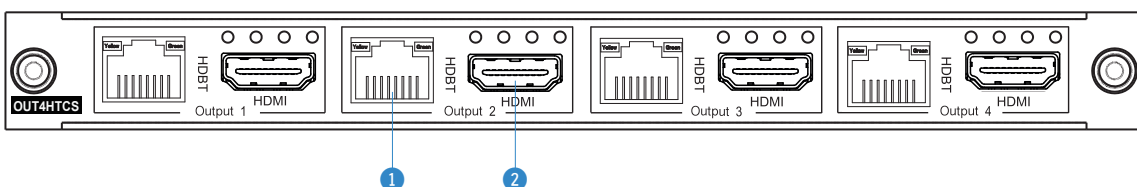

- 1 HDBaseT™ PoC Outputs (RJ45)
- 2 HDMI Outputs

Custom Pro Matrix Output Boards

PRO-OUT4TCS - 4-Way HDBaseT™ CSC Output Board (4K 60Hz 4:4:4 - 18Gbps to 70m)

- 4 x HDBaseT™ CSC, RJ45
- Supports 70m at 4K 60Hz 4:4:4, or 100m at 1080p when used with the HEX100CS-RX
- HEX70CS-RX can be used where CAT cable distance is less than 40m at 4K 60Hz 4:4:4, or 70m at 1080p
- Supports PoC (Power over Cable) to compatible Blustream HDBaseT™ receivers

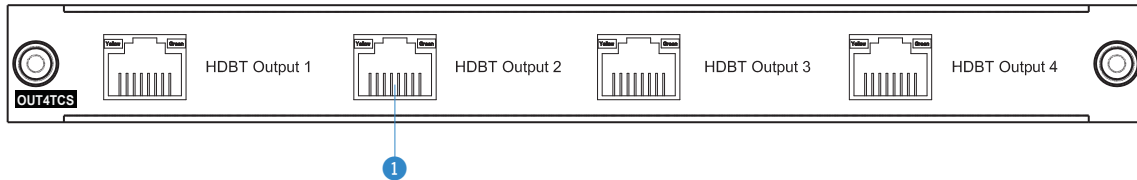

- 1 HDBaseT™ PoC Outputs (RJ45)

PRO-OUT2TCS - 2-Way HDBaseT™ CSC Output Board (4K 60Hz 4:4:4 - 18Gbps to 70m)

- 2 x HDBaseT™ CSC, RJ45
- Supports 70m at 4K 60Hz 4:4:4, or 100m at 1080p when used with the HEX100CS-RX
- HEX70CS-RX can be used where CAT cable distance is less than 40m at 4K 60Hz 4:4:4, or 70m at 1080p
- Supports PoC (Power over Cable) to compatible Blustream HDBaseT™ receivers

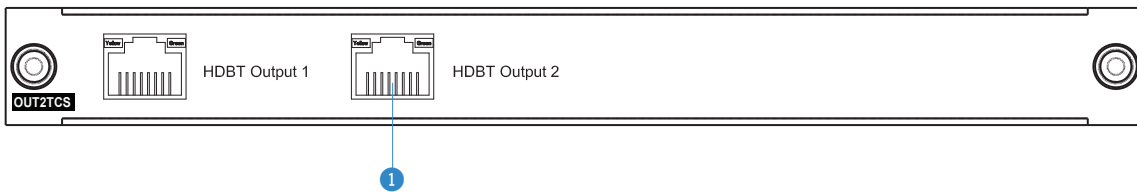

- 1 HDBaseT™ PoC Outputs (RJ45)

PRO-OUT4TLS-V2 - 4-Way HDBaseT™ CSC / HDMI2.0 Output Board (4K 60Hz 4:4:4 - 18Gbps to 40m)

- 4 x HDBaseT™ CSC, RJ45
- 4 x Simultaneous HDMI 2.0, female
- Supports 40m at 4K 60Hz 4:4:4, or 70m at 1080p when used with the HEX70CS-RX
- Supports PoC (Power over Cable) to compatible Blustream HDBaseT™ receivers

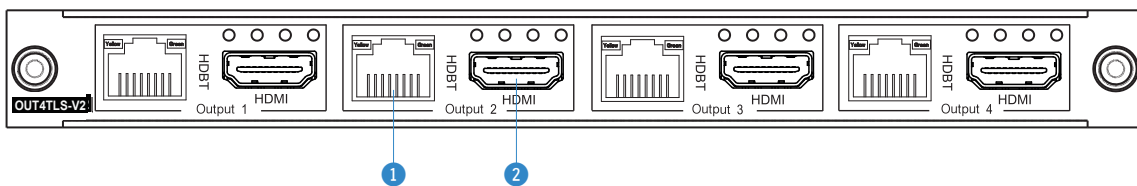

- 1 HDBaseT™ PoC Outputs (RJ45)
- 2 HDMI Outputs

Custom Pro Matrix Output Boards

PRO-OUT4TL-V2 - 4-Way HDBaseT™ CSC Output Board (4K 60Hz 4:4:4 - 18Gbps to 40m)

- 4 x HDBaseT™ CSC, RJ45
- Supports 40m at 4K 60Hz 4:4:4, or 70m at 1080p when used with the HEX70CS-RX
- Supports PoC (Power over Cable) to compatible Blustream HDBaseT™ receivers

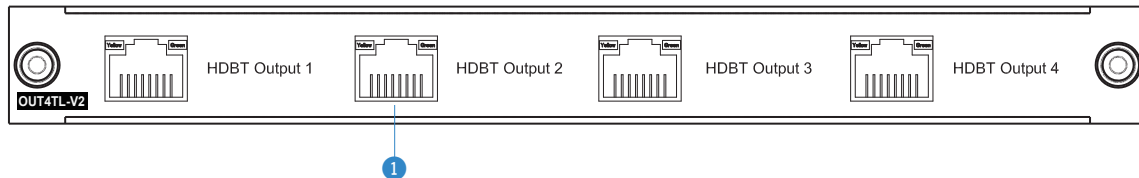

- 1 HDBaseT™ PoC Outputs (RJ45)

PRO-OUT2TL-V2 - 2-Way HDBaseT™ CSC Output Board (4K 60Hz 4:4:4 - 18Gbps to 40m)

- 2 x HDBaseT™ CSC, RJ45
- Supports 40m at 4K 60Hz 4:4:4, or 70m at 1080p when used with the HEX70CS-RX
- Supports PoC (Power over Cable) to compatible Blustream HDBaseT™ receivers

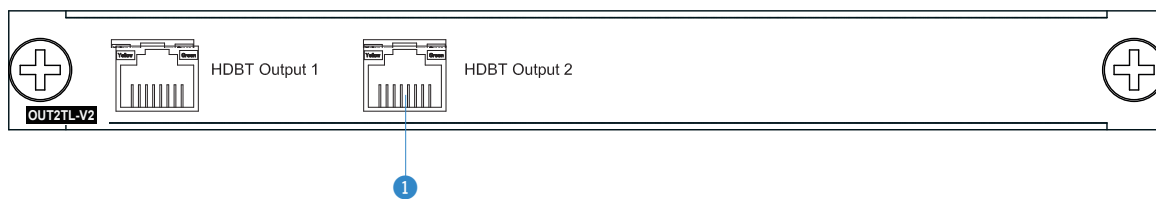

- 1 HDBaseT™ PoC Outputs (RJ45)

Automatic Smart Scaling Functionality in CSC

Blustream HDBaseT™ CSC output boards have an in-built automatic smart scaling feature allowing for a 4K video signal to be independently downscaled per individual HDBaseT™ output connection. The output card will read the EDID of the display attached to the HDBaseT™ receiver, downscaling the video resolution automatically where the display cannot accept the native resolution being sent from the source device. CSC will auto-downscale either video resolution or chroma sampling, it is not able to amend frame rate, colour depth or HDR elements within a signal. Simultaneous HDMI outputs (where available) will continue to pass the native signal.

Smart Scaling Conversion Table	
Native Source Signal	Smart Scaled Output Capability
4K xHz 4:4:4	4K xHz 4:2:0 (or) 1080p xHz
4K xHz 4:2:2	4K xHz 4:2:0 (or) 1080p xHz
4K xHz 4:2:0	1080p xHz

x = frame rate, will be equal from native to converted/scaled

Please Note: smart scaling is automatic based on the EDID of the display and cannot be controlled or adjusted by the user / integrator. To obtain resolutions lower than 1080p, a separate scaler device must be specified.

Custom Pro Matrix Feature Boards

PRO-8IR-V2 - 8-Way Bi-Directional IR Control Board

- 8 x IR inputs (IR Rx), 3.5mm stereo jack
- 8 x IR outputs (IR Tx), 3.5mm mono jack
- 1 x Global IR input (3.5mm stereo jack), 1 x Global IR output (3.5mm mono jack)
- As standard this card is set to accept / send 5V IR signals. To change to 12V, please remove the card from the chassis and adjust the switch located towards the back of the main PCB of the control card
- 5V IR cabling supplied

Please Note: the PRO-8IR-V2 is not required for the CUSTOMPRO-HUB16. IR cards are supplied as standard within this chassis.

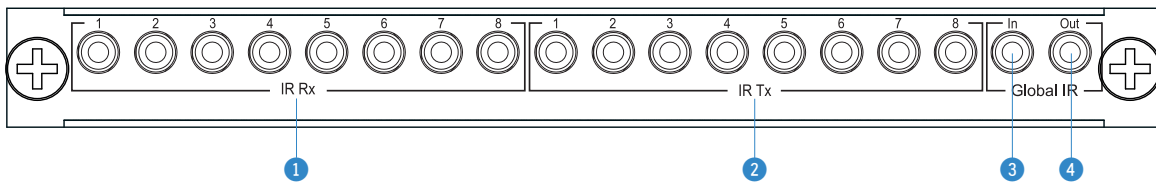

- 1 8 x 3.5mm stereo 5V/12V IR inputs for distribution of IR to compatible HDBase™ receivers
- 2 8 x 3.5mm mono 5V/12V IR outputs for routed control of local source hardware from compatible HDBase™ receivers
- 3 1 x 3.5mm stereo 5V/12V IR input for global IR control (used for control of matrix and distribution of IR to all IR TX ports)
- 4 1 x 3.5mm mono 5V/12V IR output for global IR output (all matrix / HDBase™ extender IR RX signals will output on the Global IR output)

PRO-8RS232 - 8-Way RS-232 Routing Board

- 8 x bi-directional RS-232, 3-pin phoenix
- Supplied with 8 x 3-pin phoenix connector blocks

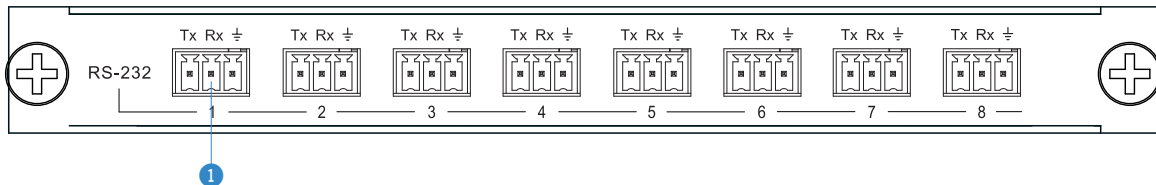

- 1 3-pin RS-232 phoenix connectors

PRO-8ABV - 8-Way Audio Breakout Board with Line Level Volume Control

- 8 x coaxial digital, RCA
- 8 x simultaneous analogue L/R, 3.5mm stereo jack

Please Note: when using the analogue audio outputs, the audio input must be 2ch PCM audio as the Custom Pro matrix does not down-mix multichannel audio signals.

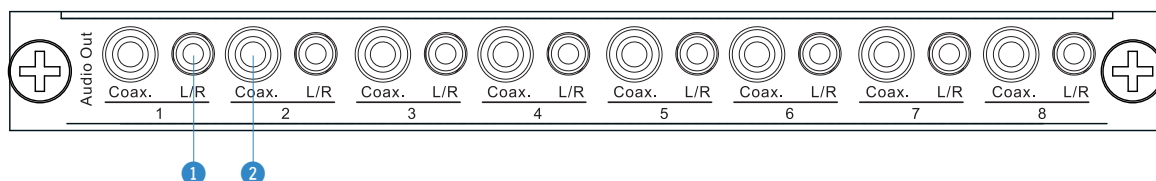

- 1 Analogue fixed 2ch output 3.5mm stereo jack
- 2 Coaxial digital output

Installing Modular Matrix Boards

Installing the modular matrix boards in the chassis is a simple process, but please note the following:

1. Power down the matrix and **remove** the external power supply **prior** to removing or installing the modular boards.
 2. Handle the boards with care, ensuring that components on the boards are not knocked or damaged during installation.
 3. Slide the board within the plastic guide rails on the inside of the chassis.
 4. When installing the modular boards please make sure the board is located firmly within the chassis, and the retaining screws are tightened by hand to secure the board into position. Do not overtighten.
 5. The Custom Pro matrix can only support a maximum of 8 x inputs (2 x modular boards) and 8 x outputs (2 x modular boards) for the 8x8 chassis, and a maximum of 16 x inputs (4 x modular boards) and 16 x outputs (4 x modular boards) for the 16x16 chassis.
- Location/s **A** - main communication board only (supplied)
 - Location/s **B** - RS-232 routing board/s only
 - Location/s **C** - video input board/s only
 - Location/s **D** - audio breakout board/s only
 - Location/s **E** - bi-directional IR control board/s only (supplied in the 16x16 chassis)
 - Location/s **F** - video output board/s only

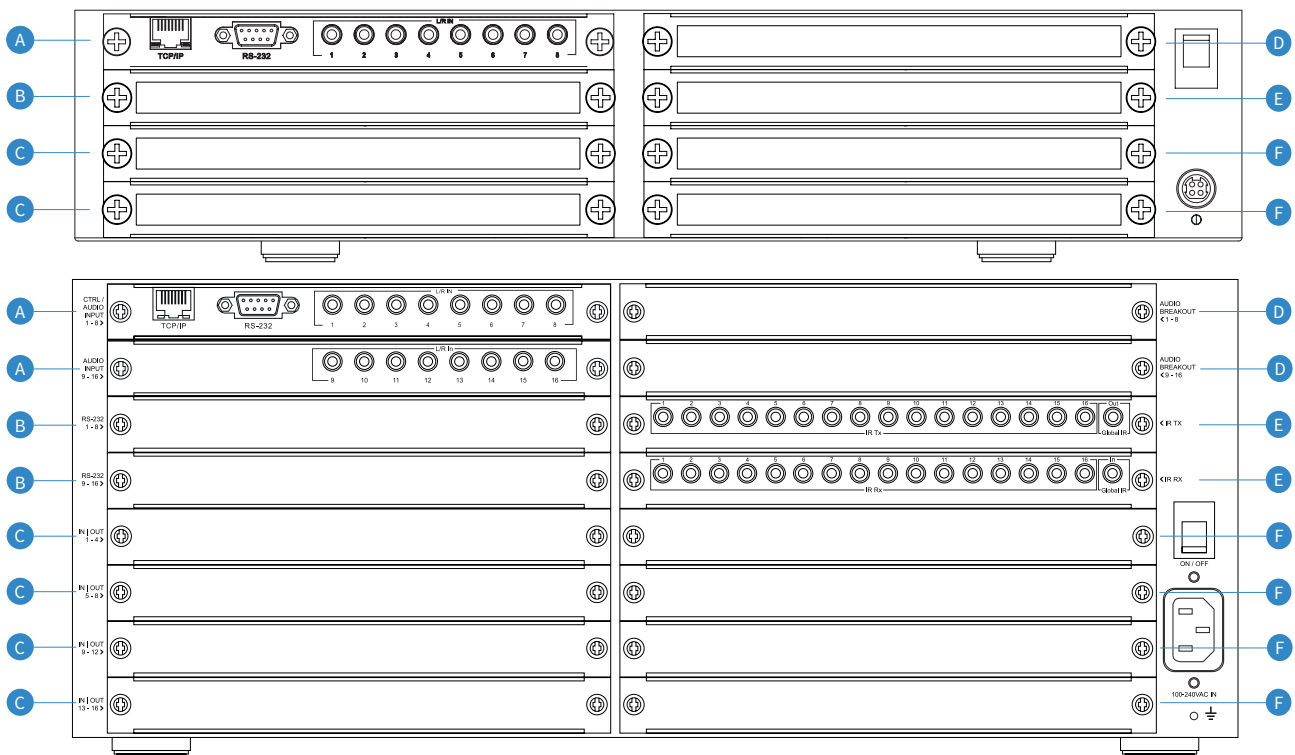

Once all Custom Pro matrix modular boards are installed, connect the external power supply and power the matrix.

HDBaseT™ Transmitter & Receiver Options

There are recommended Blustream HDBaseT™ transmitter and receiver options that are compatible with the HDBaseT™ CSC input and output boards of the Custom Pro matrix:

HEX70CS-TX - HDBaseT™ Transmitter

- HDBaseT™ CSC transmitter with HDMI loop out
- 2-Way 5V or 12V IR, and RS-232 pass-through
- Local EDID management
- Supports distances up to 40m @ 4K 60Hz 4:4:4, and 70m @ 1080p

Please Note: IR routing requires PRO-8IR-V2 board. RS-232 routing requires PRO-8RS232 board.

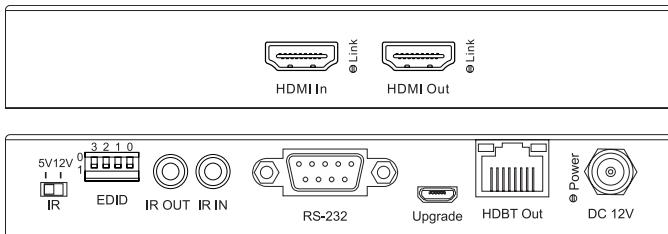

HEX100CS-TX - HDBaseT™ Transmitter

- HDBaseT™ CSC transmitter with HDMI loop out
- 2-Way 5V or 12V IR, and RS-232 pass-through
- Local EDID management
- Supports distances up to 70m @ 4K 60Hz 4:4:4, and 100m @ 1080p

Please Note: IR routing requires PRO-8IR-V2 board. RS-232 routing requires PRO-8RS232 board.

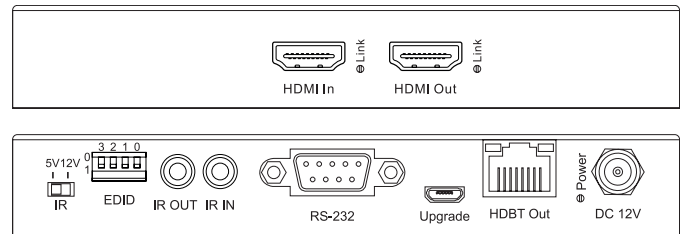

HEX70CS-RX - HDBaseT™ Receiver

- HDBaseT™ CSC receiver
- 2-Way IR, and RS-232 pass-through
- Audio breakout (simultaneous coaxial digital and 2x RCA L/R analogue fixed 2ch output)
- Supports distances up to 40m @ 4K 60Hz 4:4:4, and 70m @ 1080p
- PoC (Power over Cable) to power receiver from matrix output

Please Note: IR routing requires PRO-8IR-V2 board. RS-232 routing requires PRO-8RS232 board.

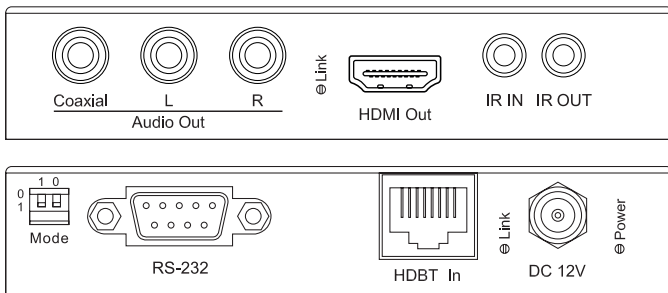

HEX100CS-RX - HDBaseT™ Receiver

- HDBaseT™ CSC receiver
- 2-Way IR, and RS-232 pass-through
- Audio breakout (simultaneous coaxial digital and 2x RCA L/R analogue fixed 2ch output)
- Supports distances up to 70m @ 4K 60Hz 4:4:4, and 100m @ 1080p
- PoC (Power over Cable) to power receiver from matrix output

Please Note: IR routing requires PRO-8IR-V2 board. RS-232 routing requires PRO-8RS232 board.

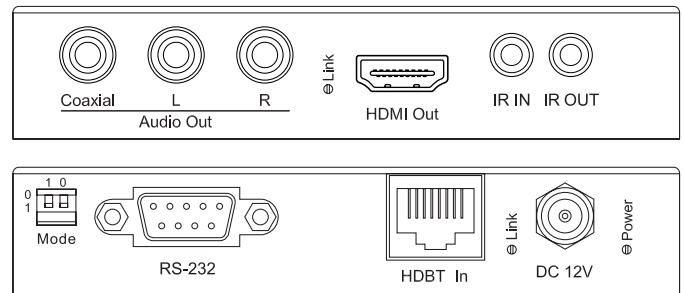

Using Other Blustream HDBaseT™ Receivers or Transmitters

Whilst HDBaseT™ as a technology is interoperable, and Blustream have designed their HDBaseT™ equipment to be interoperable, using other HDBaseT™ receivers or transmitters will likely limit the performance of the system. The HDBaseT™ receivers and transmitters noted above have been designed to specifically work, and are recommended with the Custom Pro HDBaseT™ output and input boards. Please always check PoC requirements for Receivers.

Matrix Front Panel Control

Front Panel Display - Input / Output Selection

The front display shows current source input / output selection for all zones on the 8x8 chassis. The 16x16 chassis will display 4 x zones at a time, and will periodically scroll through all outputs with the relevant input selection displayed.

The front panel display will time out after a period of inactivity - press any button to wake the screen. Time out can be disabled by issuing a command to the matrix - see RS-232 and Telnet Commands towards the rear of this manual.

1. To change input selection first press 'OUTPUT' button (1-x), or combination of buttons to select the desired zone.
2. Press desired 'INPUT' button (1-x), or combination of buttons to select the desired source input.
3. An 'X' on the front panel indicates that the zone output has been turned off. Zone outputs can be turned on / off using RS-232 or TCP/IP commands. Zone outputs can be forced back on by powering OFF / ON the matrix. All outputs will be turned on when the matrix is powered back on

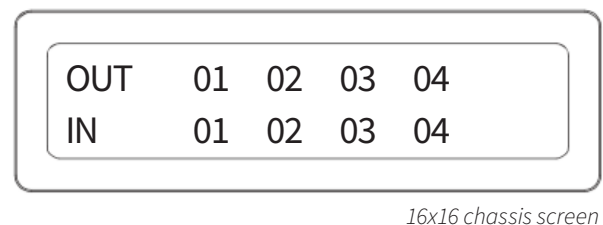
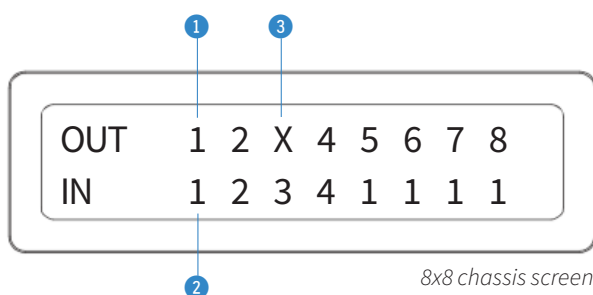

Menu Structure

The following items can be accessed from the front panel of either chassis:

1. EDID Settings - choose the EDID required per input or as a global EDID setting for ALL inputs
2. Network Configuration - choose between: Auto or Static DHCP, view current IP address, set a new IP address, Gateway, and Subnet Mask
3. F/W Version of the matrix. **Please Note:** matrix firmware cannot be upgraded from the front panel of the matrix. Firmware upgrading is carried out using firmware upgrade software. Please contact a member of the Blustream Technical Support Team for more information.

Advanced EDID Management

EDID (Extended Display Identification Data) is a data structure that is used between a display and a source. This data is used by the source to find out what audio and video resolutions are supported by the display. From this information the source will discover what the best audio and video resolutions need to be output.

Whilst the objective of EDID is to make connecting a digital display to a source a simple plug and play procedure, issues can arise when multiple displays or video matrix switching is introduced because of the increased number of variables.

By pre-determining the video resolution and audio format from the source, you can potentially reduce the time needed for the EDID part of the handshake, thus making switching both quicker, and more reliable.

As standard, Blustream distribution products containing EDID management will be set to 1080p video resolution with 2ch audio by default. This is for ease of obtaining both video and audio on first connection from most consumer and commercial source devices on the market. The EDID can then be adjusted accordingly to obtain alternative resolutions of video and audio, as required, per source device.

Configuration of matrix input EDID settings can be achieved in one of four ways:

1. Using the matrix web-GUI - see page 7 for details, or download the 'Blustream Web Browser Interface Guide' from the Blustream website for more in depth instructions. **Recommended** - when setting EDID for multiple inputs.
2. Using TCP/IP or RS-232 commands - see API towards the rear of this manual for further details
3. Using the matrix front panel buttons - only recommended when setting an individual / global EDID
4. Using the supplied matrix IR remote control (8x8 matrix product only) - for further details see page 19 (only recommended when setting an individual EDID where access to front panel or the web-GUI is not available*)

* The Custom Pro matrix does not feedback a prompt for successful setting of EDID using the IR remote control, therefore it is only recommend to use this method where other options are not available.

Terminating CAT Cable for use with HDBaseT™

It is important that the interconnecting CAT cable between Blustream HDBaseT™ products is terminated using the correct RJ45 pin configuration. The link CAT cable MUST be a 'straight' (pin-to-pin) CAT cable, and it is advised that this is wired to the T568B wiring standard as this format is less prone to EMI (Electro-Magnetic Interference).

When installing CAT cables it is advised that you use the best possible CAT cable quality. HDMI distribution products will only work if used with Cat5e standard cable or above. Blustream recommends using a Cat6 cable (or better) for installations, especially when running longer distances, in areas of high EMI, or for 4K signal distribution. It is advised that using any method of patch panel, wall plate, or join within the CAT cable is avoided as these can add degradation to the signal. Blustream also recommend using RJ45 connectors that are recommended for use with the choice of CAT cable.

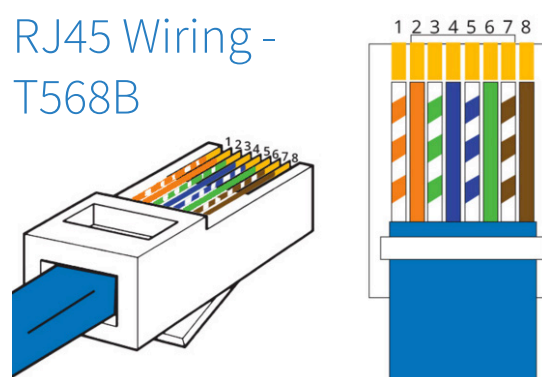

Understanding the HDBaseT™ Status LED's

The Custom Pro matrix and HDBaseT™ extender solutions include status LED indicators on the matrix, transmitter, and receiver products to show all connections are active, and to help diagnose potential connectivity issues.

Understanding the Status Lights - Custom Pro Matrix:

- The yellow HDBaseT™ status link light will be OFF when the input / output has been turned off, PoC (Power over Cable) has been turned off, or there is a problem with the specific matrix input / output
- The yellow HDBaseT™ status link light will BLINK when the input / output is on and working
- The green HDBaseT™ link light will BLINK if there is an unstable connection between the matrix and HDBaseT™ transmitter / receiver
- The green HDBaseT™ link light will be ON when there is an active HDBaseT™ transmitter / receiver connected to the matrix
- The green HDBaseT™ link light will be OFF when there is no connection with a HDBaseT™ transmitter / receiver

Understanding the Status Lights - Blustream HDBaseT™ Transmitter / Receiver:

- The power link light will be OFF when no power is being received from either the matrix or from a local PSU connected directly to the transmitter / receiver (**Please Note:** HDBaseT™ inputs of the Custom Pro matrix do not supply PoC to Blustream HDBaseT™ transmitters)
- The power link light will be ON when power is being received from either the matrix or from a local PSU connected directly to the transmitter / receiver
- The HDMI link light will be off when there is no connection with a source / repeater / display
- The HDMI link light will be ON when there is an active connection with a source / repeater / display (**Please Note:** not all Blustream HDBaseT™ transmitters / receivers feature a HDMI status LED)
- The HDBaseT™ link light will be OFF when there is no CAT cable / active HDBaseT™ connection to the RJ45 HDBaseT™ input / output
- The HDBaseT™ link light will BLINK if there is an unstable connection between the matrix and HDBaseT™ transmitter / receiver
- The HDBaseT™ link light will be ON when a CAT cable is connected to the HDBaseT™ RJ45 input / output on the matrix and an active connection is achieved with the Blustream HDBaseT™ transmitter / receiver

The link lights will only serve as an indication to the connectivity between matrix and remote transmitter and / or receiver unit.

The LED's will not indicate a termination, bandwidth, interference or cable length issue on a CAT cable run. Blustream would always recommend qualifying / verifying / certifying a CAT cable run for suitability prior to the installation of HDBaseT™ equipment.

Audio Functionality

The Custom Pro matrix has the ability to embed or de-embed audio at various points of the system dependent on the use-case for the install.

Audio Embedding:

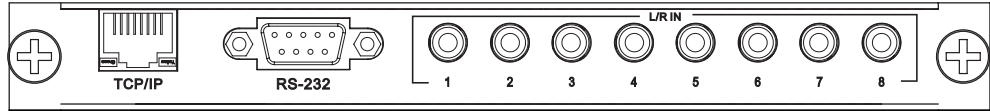

The 3.5mm analogue stereo inputs located on the main chassis control card allow for 2ch audio to be embedded onto the associated video input (i.e. L/R In 3 is permanently linked to video input 3). The original embedded audio is discarded when embedding audio, the matrix will not mix the input audio with the original source audio. Where a VGA is input using the PRO-IN2H2V card, the associated audio from the source device can be inserted here. Enabling the audio stream from these inputs is carried out by issuing an RS-232 or TCP/IP command to the matrix. Please refer to the RS-232 / Telnet command section later in this manual for further details.

Please Note: audio inputs cannot be routed independently to video.

Source Audio Breakout:

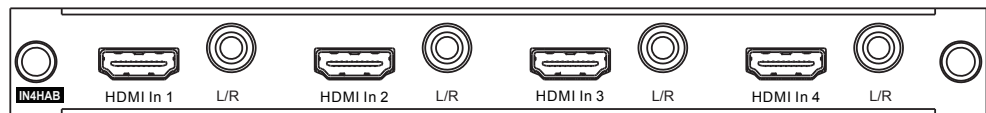

The 3.5mm L/R analogue outputs contained on the PRO-IN2HAB, PRO-IN4HAB and PRO-IN2H2TCS cards can be used to breakout the 2ch PCM audio embedded from the source video input of the matrix. This signal can be used to feed a separate audio matrix product that requires the source audio input, as opposed to a zone matrix output audio that would change as the I/O structure of the matrix changes with switching.

Please Note: the L/R audio output does not down-mix multichannel audio signals to 2ch. The HDMI source audio must be 2ch PCM to obtain a breakout from these 3.5mm outputs.

Zone Audio Breakout:

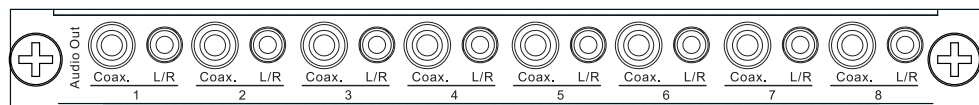

Both stereo and digital audio can be broken out from the audio breakout card/s. The audio from these outputs changes with the I/O structure of the matrix - therefore, audio will follow the associated output of the video output card/s (i.e. Coax and L/R 4 is permanently linked to video output 4). The video signal retains the embedded audio signal with the video, to be carried through to the sink attached to the output.

Please Note: the Coax digital and L/R analogue audio outputs are concurrent and do not down-mix multichannel audio signals. The Coax digital output can handle a digital audio stream up to 7.1ch.

The Custom Pro matrix solution does not support ARC (Audio Return Channel) through any of the input, output, or audio board configurations.

Infrared (IR) Distribution

The Blustream Custom Pro matrix products include multiple options for control and routing of IR when using the IR control boards. IR matricing can be achieved (routed IR from zone to any matrix output, or matrix input to any receiver output), using TCP/IP or serial commands to select the route an IR signal can be sent from / to.

The Blustream PRO-8IR-V2 control board, and the CUSTOMPRO-HUB16 are supplied with a selection of IR hardware (see Package Contents towards rear of this manual), and includes:

IR Emitter - IRE1

Blustream 5V IR emitter designed for discrete IR control of hardware.

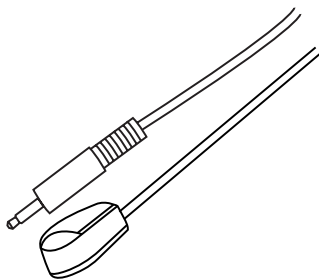

Infrared 3.5mm Pin-Out

IR Emitter - Mono 3.5mm

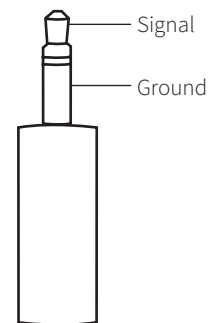

IR Receiver - IRR

Blustream 5V IR receiver to receive IR signal and distribute through Blustream products.

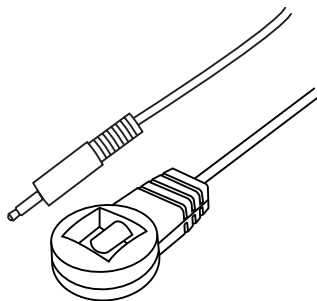

IR Receiver - Stereo 3.5mm

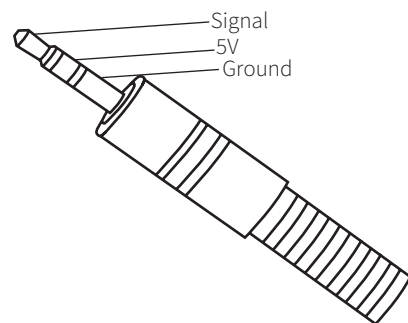

IR Control Cable - IRCAB

Blustream IR control cable 3.5mm stereo to 3.5mm mono for linking 12V third party control solutions to Blustream 5V products via IR.

Please Note: cable is directional as indicated.

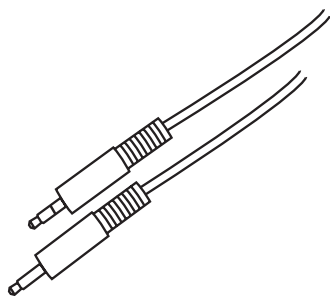

Please Note: Blustream IR hardware do not include flashing diodes to indicate IR signals being emitted or received.

Relevant IR cabling is supplied with the 16x16 chassis, please see package contents towards the rear of this manual.

When purchasing the PRO-8IR-V2 with the 8x8 chassis, the following IR cables are provided:

- 9 x IR emitter (IRE1)
- 9 x IR receiver (IRR)
- 9 x IR 3.5mm - 3.5mm stereo to mono, 12V to 5V control cable (IRCAB)

Infrared (IR) Control

The Blustream Custom Pro matrix units are supplied with an IR Remote Control for source selection and general setup. As well as controlling matrix solutions using the original Blustream remote, Blustream products can also be controlled using the original Infrared NEC codes documented towards the rear of this manual.

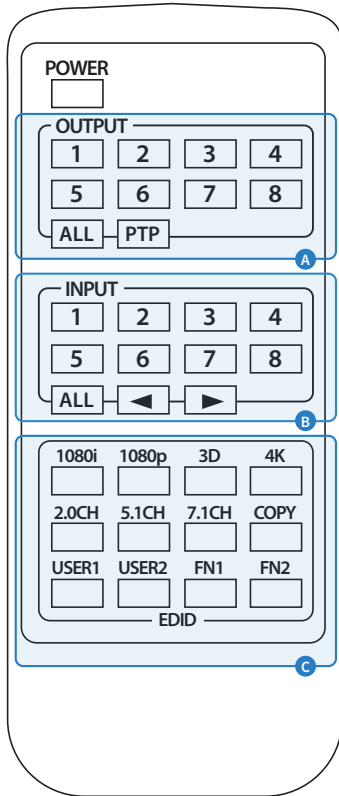

OUTPUT AND INPUT SELECTION

The remote adjacent is supplied with the 8x8 chassis. The remote adjacent/below is supplied with the 16x16 chassis.

When controlling the I/O structure of the matrix (issuing the command from the remote, to the front of the matrix):

1. Select the OUTPUT you wish to change the input source of - numbers 1 - 8/16 correspond to the zone outputs 1 - 8/16 - highlighted in box A.
2. Select the INPUT you wish to change on the selected zone to - numbers 1 - 8/16 correspond to the source inputs 1 - 8/16 - highlighted in box B.
3. Press the PTP button if you wish to instantly mirror all inputs to corresponding outputs (for example - input 1 to output 1, input 2 to output 2 etc).

When controlling the I/O structure of the matrix when located within a zone (where IR is sent over HDBaseT™ to the matrix), it is only necessary to press the relevant INPUT button, or the left / right scrolling buttons.

Please Note: the POWER button will only work when the command is issued to the front panel (IR window) of the matrix, not from an IR receiver within a zone.

EDID SET UP VIA REMOTE CONTROL

The Custom Pro matrix provides a comprehensive range of EDID settings. Below are three examples of how to deploy the desired EDID setting when using the supplied remote for the 8x8 Custom Pro matrix (not available with the 16x16*):

1. Fix EDID to an input, or ALL inputs: press the desired video resolution button (1080i / 1080p / 3D / 4K), select the desired audio format (2.0ch / 5.1ch / 7.1ch), then select the source input you want this EDID information allocated to by pressing the INPUT 1 – 8, or the ALL button.
2. Copy EDID of output (X) to an input or ALL: Press the COPY button then select the OUTPUT you wish to copy the EDID information from, then select the source input you want to copy this EDID to by selecting the INPUT 1 - 8 or the ALL button.
3. User defined EDID to an input, or ALL inputs: Press USER1 / USER2 button then select the source you wish to assign this EDID to by selecting INPUT 1 - 8, or the ALL button.

* EDID management for the 16x16 Matrix product can only be carried out using the web-GUI, front panel buttons, Blustream Matrix App, or by issuing RS-232 / IP commands to the unit, and not from the supplied IR remote control.

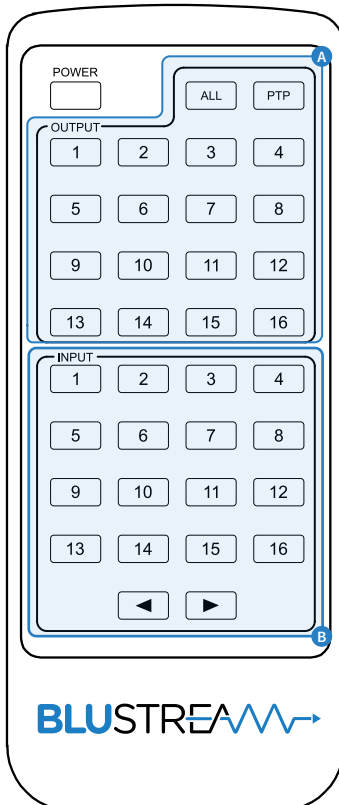

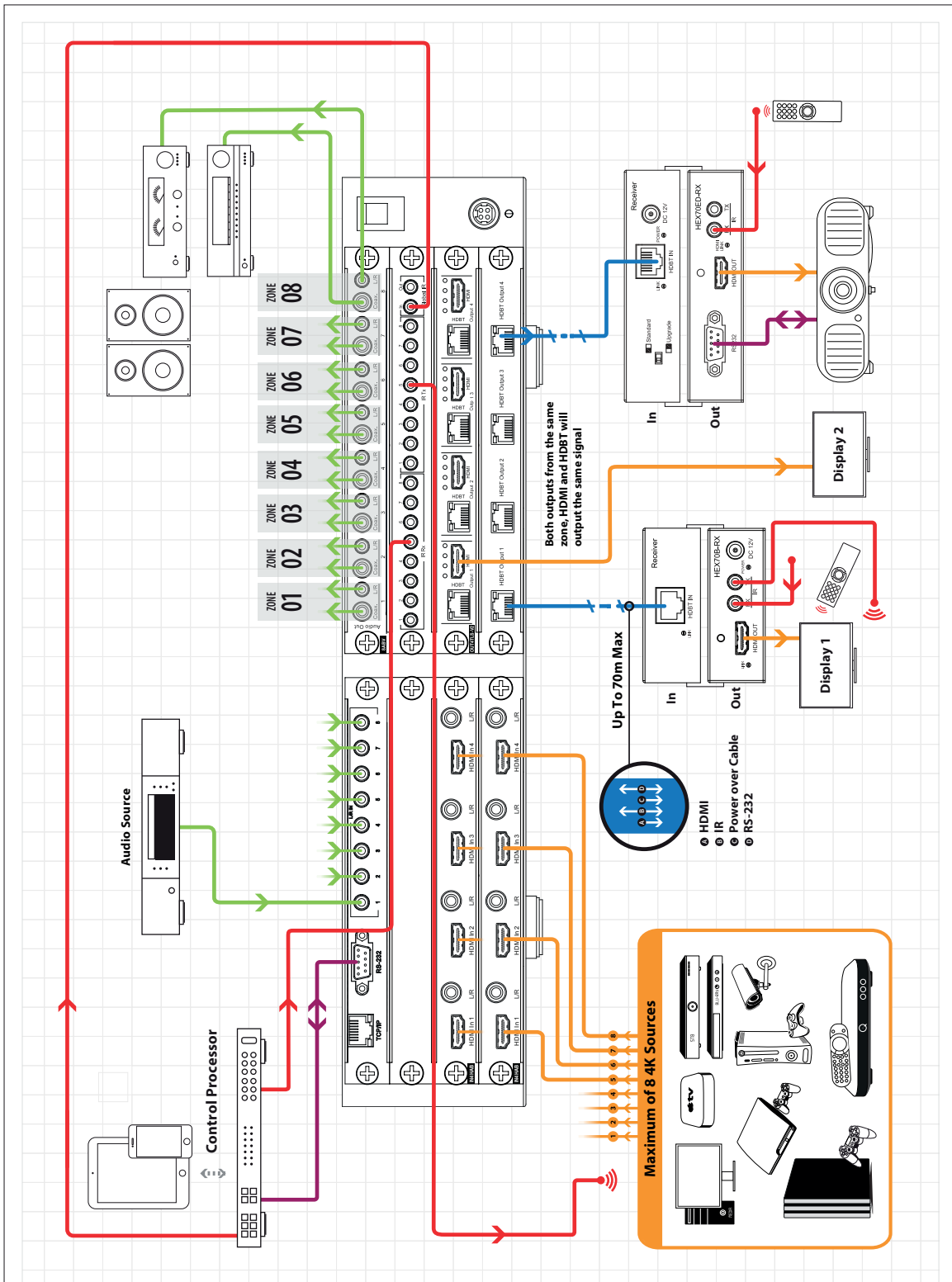

Example Schematic
8x8 Chassis

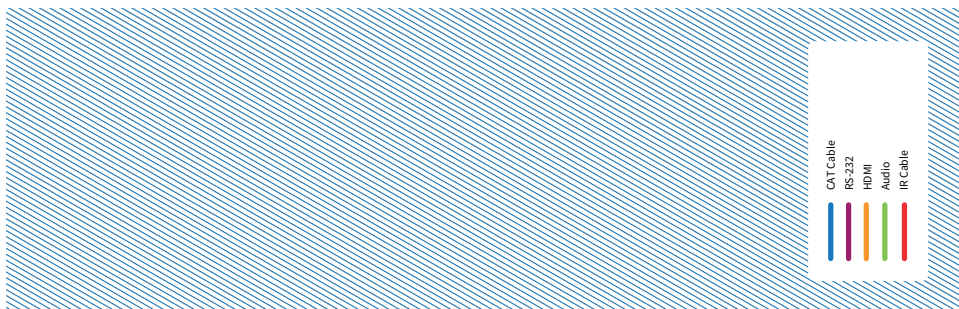

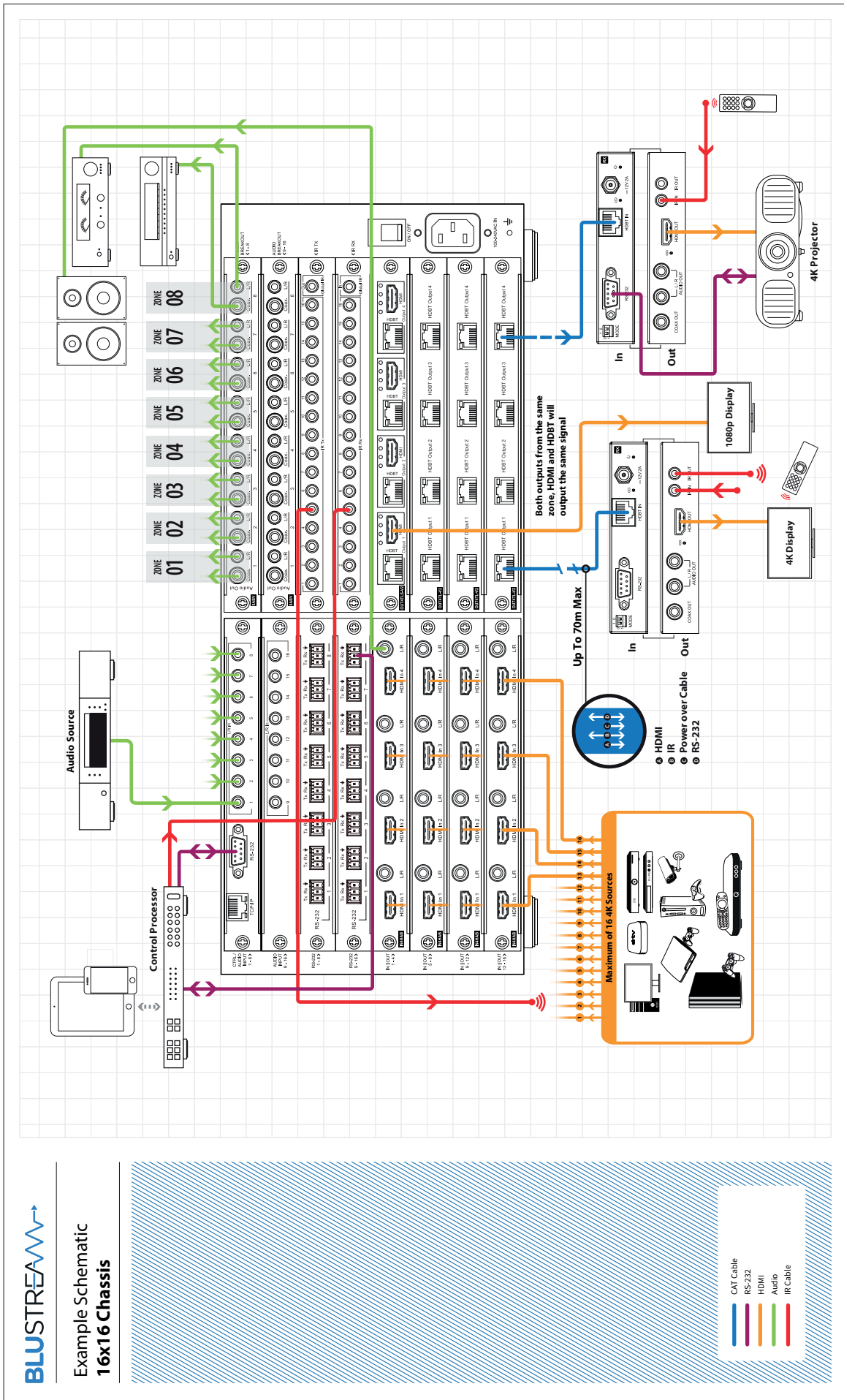

BLUSTREAM

Example Schematic
16x16 Chassis

- CAT Cable
- RS-232
- HDMI
- Audio
- IR Cable

Specifications

CUSTOMPRO-HUB Modular (8x8) Chassis

Audio Input Connections: 8 x 3.5mm stereo jack

RS-232 Serial Port: 1 x DB-9, female

TCP/IP Control: 1 x RJ45, female

Rack Mountable: 2U rack height, rack ears included

Casing Dimensions (W x D x H): 440mm x 283mm x 87mm, without feet

Dimensions (W x D x H): 440mm x 291mm x 94mm, with feet and connections

Shipping Weight: 5.5kg

Operating Temperature: 32°F to 104°F (0°C to 40°C)

Storage Temperature: -4°F to 140°F (-20°C to 60°C)

Power Supply: 1 x 24V/8A DC transformer to 4-pin DIN

CUSTOMPRO-HUB16 Modular (16x16) Chassis

Audio Input Connections: 16 x 3.5mm stereo jack

RS-232 Serial Port: 1 x DB-9, female

TCP/IP Control: 1 x RJ45, female

IR Input Connections: 17 x 3.5mm stereo jack

IR Output Connections: 17 x 3.5mm mono jack

Rack Mountable: 4U rack height, rack ears included

Casing Dimensions (W x D x H): 440mm x 422mm x 173mm, without feet

Dimensions (W x D x H): 440mm x 430mm x 178mm, with feet and connections

Shipping Weight: 11kg

Operating Temperature: 32°F to 104°F (0°C to 40°C)

Storage Temperature: -4°F to 140°F (-20°C to 60°C)

Power Supply: Internal 100-240V AC, IEC cables supplied

Package Contents

CUSTOMPRO-HUB

- 1 x CUSTOMPRO-HUB (including Control Board)
- 1 x Rack Mounting Kit
- 1 x 24V/8A DC Power Supply & IEC power cabling
- 1 x Remote Control (REM88)
- 1 x Quick Reference Guide

CUSTOMPRO-HUB16

- 1 x CUSTOMPRO-HUB16 (including Control Boards, and IR Routing Boards)
- 1 x Rack Mounting Kit
- IEC Power Cabling
- 1 x Remote Control (REM16)
- 4 x IR Emitter (IRE1)
- 5 x IR Receiver (IRR)
- 5 x IR 3.5mm - 3.5mm Stereo to Mono, 12V to 5V Control Cable (IRCAB)
- 1 x Quick Reference Guide

Maintenance

Clean this unit with a soft, dry cloth. Never use alcohol, paint thinner or benzene to clean this unit.

RS-232 and Telnet Commands

The Blustream Custom Pro matrix can be controlled via serial and/or TCP/IP. The following pages list all available commands for the Custom Pro matrix chassis. Details of RS-232 pin assignment below:

CUSTOM PRO		REMOTE CONTROL CONSOLE	
PIN	Assignment	PIN	Assignment
1	NC	1	NC
2	Tx	2	Rx
3	Rx	3	Tx
4	NC	4	NC
5	GND	5	GND
6	NC	6	NC
7	NC	7	NC
8	NC	8	NC
9	NC	9	NC

Baud rate: 57600 bps

Data bit: 8-bit

Parity: none

Stop bit: 1-bit

Flow control: none

Commonly Used Serial Commands:

There are several commands that are commonly used for control and testing:

- STATUS** Status will give feedback on matrix such as zones on, type of connection etc
- ?** Lists all commands the matrix can accept
- PON** Matrix power on
- POFF** Matrix power off
- OUTxxON** (where xx is the zone number you wish to turn on)
 example: OUT01ON (this would turn output 1 back on)
- OUTxxFRyy** (where xx is the zone out, yy is the input)
 example: OUT01FR04 (this would switch output 1 to source input 4)

Common Mistakes:

- Carriage return – some programs do not require a carriage return, where others will not work unless sent directly after the string. In the case of some terminal software the token <CR> is used to execute a carriage return. Depending on the program being used, this token may be different. Some other examples that other control systems deploy include \r or 0D (in hex).
- Spaces – Blustream products do not require spacing between commands unless specified. There may however be some terminal programs that will require spacing in order to work:
 - How the string should look: OUT01ON
 - How the string may look if spaces are required: OUT {Space} 01 {Space} ON
- Baud rate or other serial protocol settings not correct.

RS-232 and Telnet Commands

COMMAND	ACTION
?	Print help information
HELP	Print help information
STATUS	Print system status and port status
PON	Power On, system run on normal state
POFF	Power Off, system run on power save state
IR ON/OFF	Set system IR control On or Off
KEY ON/OFF	Set system (front panel) KEY control On or Off
BEEP ON/OFF	Set onboard beep On or Off
LCD ON/OFF	Set LCD always On or Auto turn off in power on state
RSB x	Set baud rate to x bps x = 0: 115200 x = 1: 57600 x = 2: 38400 x = 3: 19200 x = 4: 9600
RESET	Reset system to default setting
RESET ALL	Reset system and network to default setting (type "Yes" to confirm, "No" to Discard)
IN CSC ON/OFF	Set all Input ports CSC mode On or Off
OUT CSC ON/OFF	Set all Output ports CSC mode On or Off
IN xx UHD ON/OFF	Set INPUT:xx EDID support UHD mode On or Off xx=[00]: ALL Input port, [01...16]: Input port
AUD STA	Print Input/Output port audio setting state
AUD RX xx ORG	Input port:xx use original receive HDMI/DVI signal
AUD RX xx ANA	Input port:xx insert stereo to HDMI/DVI signal
AUD RX xx AUTO	Input port:xx insert stereo to DVI signal only xx=[00]: All Input Port, [01...08]: Input Port

COMMAND	ACTION
VOL xx TX yy	Set output audio:yy volume to:xx yy=[00]: All output audio, [01..16]: Output audio xx=[00..100]: volume value xx=+: Volume increase xx=-: Volume decrease
MUTE ON/OFF TX yy	Set output audio:yy Mute On or Off yy=[01..16]: Output audio
OUT xx ON/OFF	Set OUTPUT:xx On or Off
POC TX xx ON/OFF	Output xx turn ON/OFF PoC (Keeps Zone active but cuts PoC for when output is connected to third party HDBaseT hardware)
OUT xx FR yy	Set OUTPUT:xx from INPUT:yy
OUT xx EH/ET	Set OUTPUT:xx use HDMI/HDBT EDID xx=[00]: All OUTPUT port, [01...08]: OUTPUT port yy=[01...08]: INPUT port
MUTE ON/OFF OUT yy	Set output audio: yy mute ON or OFF
NET DHCP ON/OFF	Set auto IP (DHCP) ON or OFF
NET IP xxx.xxx.xxx.xxx	Set IP address
NET GW xxx.xxx.xxx.xxx	Set gateway address
NET SM xxx.xxx.xxx.xxx	Set subnet mask address
NET RB	Set network reboot and apply new config
NET TN xxxx	Set telnet port
PRESET STATUS	Print present config status
PRESET pp SET aa, bb, cc ... oo, pp	Set preset config pp=[01..08]: select preset index aa=[01..16]: output 01 from aa, [00]: not set bb: output 02 ... pp: output 16
PRESET pp SAVE	Save current output connection to preset:pp config
PRESET pp APPLY	Apply preset:pp config to output connection

RS-232 and Telnet Commands

COMMAND	ACTION
EDID xx CP yy	Set input:xx EDID copy from output:yy
EDID xx DF zz	<p>Set Input:xx EDID To Default EDID:zz</p> <p>xx=[00]: All INPUT Port, [01...06]: INPUT Port</p> <p>yy=[01...06]: OUTPUT Port</p> <p>zz=00: HDMI 1080p@60Hz, Audio 2ch PCM</p> <p>zz=01: HDMI 1080p@60Hz, Audio 5.1ch DTS/DOLBY</p> <p>zz=02: HDMI 1080p@60Hz, Audio 7.1ch DTS/DOLBY/HD</p> <p>zz=03: HDMI 1080i@60Hz, Audio 2ch PCM</p> <p>zz=04: HDMI 1080i@60Hz, Audio 5.1ch DTS/DOLBY</p> <p>zz=05: HDMI 1080i@60Hz, Audio 7.1ch DTS/DOLBY/HD</p> <p>zz=06: HDMI 1080p@60Hz/3D, Audio 2ch PCM</p> <p>zz=07: HDMI 1080p@60Hz/3D, Audio 5.1ch DTS/DOLBY</p> <p>zz=08: HDMI 1080p@60Hz/3D, Audio 7.1ch DTS/DOLBY/HD</p> <p>zz=09: HDMI 4K@30Hz 4:4:4, Audio 2ch PCM</p> <p>zz=10: HDMI 4K@30Hz 4:4:4, Audio 5.1ch DTS/DOLBY</p> <p>zz=11: HDMI 4K@30Hz 4:4:4, Audio 7.1ch DTS/DOLBY/HD</p> <p>zz=12: DVI 1280x1024@60Hz, Audio None</p> <p>zz=13: DVI 1920x1080@60Hz, Audio None</p> <p>zz=14: DVI 1920x1200@60Hz, Audio None</p> <p>zz=15: User EDID 1</p> <p>zz=16: User EDID 2</p> <p>zz=17: GUI Download EDID</p> <p>zz=18: HDMI 4K@60Hz 4:2:0, Audio 2ch PCM</p> <p>zz=19: HDMI 4K@60Hz 4:2:0, Audio 5.1ch DTS/DOLBY</p> <p>zz=20: HDMI 4K@60Hz 4:2:0, Audio 7.1ch DTS/DOLBY/HD</p>
EDID SAVE yy TO ss	<p>Save output:yy EDID to user memory:ss</p> <p>ss=[01...02]: User EDID memory</p>
MXSTA	Print matrix IR and RS-232 connect state
MXIR xx FR yy	<p>Remote RX:xx IR output from local IR in:yy</p> <p>xx=[00]: All remote IR output, [01...16]: Remote RX IR output</p> <p>yy=[01...16] Local IR in</p>
MXIR GI (+-)xx	<p>Global all IR In signal goes to which IR output:xx</p> <p>xx=[17..32]: Local IR output</p> <p>xx=[33..48]: Remote HDBT receiver IR output</p> <p>+: Add xx to current setting</p> <p>-: Remove xx from current setting</p>
MXIR GO (+-)xx	<p>Global all IR Out signal goes to which IR input:xx</p> <p>xx=[17..32]: Local IR input</p> <p>xx=[33..48]: Remote HDBT receiver IR input</p> <p>xx=[49]: Global all IR in</p> <p>+: Add xx to current setting</p> <p>-: Remove xx from current setting</p>

Certifications

FCC Notice

This equipment has been tested and found to comply with the limits for a Class B digital device, pursuant to part 15 of the FCC Rules. These limits are designed to provide reasonable protection against harmful interference in a residential installation. This equipment generates, uses, and can radiate radio frequency energy and, if not installed and used in accordance with the instructions, may cause harmful interference to radio communications. However, there is no guarantee that interference will not occur in a particular installation. If this equipment does cause harmful interference to radio or television reception, which can be determined by turning the equipment off and on, the user is encouraged to try to correct the interference by one or more of the following measures:

- Reorient or relocate the receiving antenna.
- Increase the separation between the equipment and receiver.
- Connect the equipment into an outlet on a circuit different from that to which the receiver is connected.
- Consult the dealer or an experienced radio/TV technician for help.

CAUTION - changes or modifications not expressly approved by the party responsible for compliance could void the user's authority to operate the equipment.

CANADA, INDUSTRY CANADA (IC) NOTICES

This Class B digital apparatus complies with Canadian ICES-003.

Operation is subject to the following two conditions: (1) this device may not cause interference, and (2) this device must accept any interference, including interference that may cause undesired operation of the device.

CANADA, AVIS D'INDUSTRY CANADA (IC)

Cet appareil numérique de classe B est conforme aux normes canadiennes ICES-003.

Son fonctionnement est soumis aux deux conditions suivantes : (1) cet appareil ne doit pas causer d'interférence et (2) cet appareil doit accepter toute interférence, notamment les interférences qui peuvent affecter son fonctionnement.

CORRECT DISPOSAL OF THIS PRODUCT

This marking indicates that this product should not be disposed with other household wastes. To prevent possible harm to the environment or human health from uncontrolled waste disposal, recycle it responsibly to promote the sustainable reuse of material resources. To return your used device, please use the return and collection systems or contact the retailer where the product was purchased. They can take this product for environmentally safe recycling.



